

Cast Iron Radiator

BGL-661

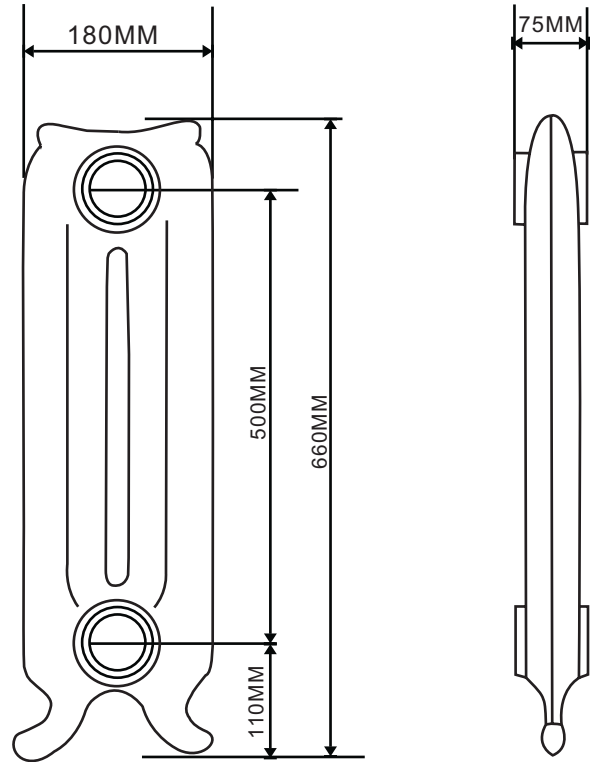

Specification	Weight	Delta 50	Delta 60
sections	kgs	watts	watts
3	31	276	330
4	40	368	440
5	50	460	550
6	60	552	660
7	70	644	770
8	79	736	880
9	89	828	990
10	99	920	1100
11	108	1012	1210
12	118	1104	1320
13	128	1196	1430
14	137	1288	1540
15	148	1380	1650